

Swimming Pool and Spa Purification System

# Pool Pilot™

## *Soft Touch*

by Aqua Cal AutoPilot Inc.

## *Owners Manual*

**Installation and Operation**

(For Indoor or Outdoor use)

**IMPORTANT**

**Read This Manual Before Installing & Operating**

#18500-ST R6 8/2007

# Pool Pilot™

## *Soft Touch*

by Aqua Cal AutoPilot Inc.

Record The Following Information

Installer: _____	Date of Installation: _____
Control Unit Model Number: <u>ST-220</u>	Control Unit Serial Number: # _____
Cell Model Number: <u>SC-</u>	Cell Serial Number: # _____

**Factory Direct Customer Assistance...**

HOTLINE: 1.800.786-7751 or 1.727.823.5642

FAX: 1.727.824.0847

[e-mail to: AutoPilotTechSupport@teamhorner.com](mailto:AutoPilotTechSupport@teamhorner.com)

**Visit Us On The Internet @**

<http://www.autopilot.com>

**Manufactured by**

Aqua Cal AutoPilot Inc.

2737 24<sup>th</sup> Street North • St. Petersburg • Florida 33713, U.S.A.

# Pool Pilot™

## *Soft Touch*

by Aqua Cal AutoPilot Inc.



# IMPORTANT SAFETY INSTRUCTIONS

## READ AND FOLLOW ALL INSTRUCTIONS

### INSTALLATION AND EQUIPMENT RELATED

#### Installation of all Pool Pilot™ Soft Touch models:

When installing and using your Pool Pilot™ Soft Touch Control Box, basic safety precautions must always be followed, including the following:

1. Follow all aspects of the local and National Electrical Code(s) when installing your Control Box.
2. During installation, mount your Control Box to ensure the least amount of direct exposure to rain, garden sprinkler water, direct sunlight or any corrosive environment.
3.  DANGER – Risk of electrical shock. Install Control Box at least 10' (3 m) for 115VAC Units, from the inside wall of the pool or spa using non-metallic plumbing. 5' (1.5 m) minimum distance for 230VAC Units.
4. All field-installed metal components such as rails, ladders, drains or similar hardware within 10' (3 m) of the spa or hot tub shall be bonded to the equipment grounding bus with copper conductors not smaller than No. 8 AWG (8.4 mm<sup>2</sup>).
5.  WARNING – Maintain water chemistry in accordance with manufacturer's instructions.
6.  DANGER – To reduce the risk of injury, do not permit children to use this product unless they are closely supervised at all times. Children should not use spas, hot tubs or pools without permanent adult supervision.

### Equipment Related

#### 115/230VAC, 50/60 Hz Models (fixed wiring)

- 1 A wire connector is provided on your Pool Pilot™ Soft Touch to connect a minimum No. 8 AWG (8.4 mm<sup>2</sup>) solid copper bonding conductor between this unit and any metal equipment, metal enclosures of electrical equipment, metal water pipe or conduit within 5' (1.5 m) of the unit.
- 2 A bonding terminal is located inside your Pool Pilot™ Soft Touch. To reduce the risk of electrical shock, this terminal must be connected to the grounding means provided in the electrical supply panel with a continuous copper wire equivalent size to the circuit conductors supplying your Pool Pilot™ Soft Touch.
- 3 A disconnection device from the power source, with a contact separation of at least 0.12" (3mm) in all poles, must be incorporated in the fixed wiring for permanently wired units.
- 4 The input voltage to the Pool Pilot™ Soft Touch must match the 115/230VAC, 50/60 Hz jumper terminals on the Circuit board, marked "TRANSFORMER PRIMARY", shown on Page 5.

## SAVE THESE INSTRUCTIONS

Table of Contents

# Pool Pilot™

## *Soft Touch*

by Aqua Cal AutoPilot Inc

**Section 1 GENERAL INFORMATION**

1a Product Information and Contact Numbers ..... 1  
1b Important Safety Instructions..... 2  
1c Table of Contents ..... 3

**Section 2 INSTALLATION**

2a Main Components..... 4  
Specifications  
2b Control Box Connections..... 5  
Electrical Connections  
Cell Cord and Tri-Sensor Connections  
ORP Connections  
2c Cell and Manifold Installation ..... 6  
Verification of Flow Switch Protection ..... 6

**Section 3 OPERATION**

3a Key Features – Control Panel ..... 7  
3b Pool Water Preparation ..... 8  
Salt Requirement Chart  
Start-Up Procedures ..... 8  
3c Monitoring and Maintenance ..... 9  
Water Chemistry Parameters  
Saturation Index

**Section 4 SERVICE and MAINTENANCE**

4a Servicing ..... 10  
Control Box  
Tri-Sensor  
4b Servicing ..... 11  
Cell Removal  
Cell Maintenance and Cleaning  
Filter Backwashing ..... 11  
4c Parts Explosion ..... 12

**Section 5 TROUBLESHOOTING**

5a Troubleshooting ..... 13

**Appendix** Diagnostics..... 14

## Main Components



**Soft Touch  
Control Box**

**CONTROL BOX** converts incoming AC power to a Low Voltage DC current, which energizes the Cell(s). Set the **Control Box** on a vertical surface away from excessive exposure to heat and moisture. Use the template to mark and drill the (4) mounting holes and insert the screws, leaving a 1/4" gap. Hang the control box on the screws and level. Remove the cover by following the steps on page 10 to access the mounting holes to tighten the screws.

**RATINGS:**

**Input Power:** 115 VAC (3.0 AC amps)  
230 VAC (1.5 AC amps)  
50/60 Hz

**Output Power:** Cell Power 1 (5.0\* DC amps)  
Cell Power 2 (6.5\* DC amps)  
Cell Power 3 (8.0\* DC amps)

\*Indicates nominal amperage output. The dual axis controller will slightly vary the amps to optimize the power to the cell.

The cell and tri-sensor are located in a Patented Automatic Flow Bypass Manifold Assembly. 12' (3.6 m) of **Cell and Tri-Sensor cords** are provided with the unit. Ensure that the manifold is located within that distance from the control box with enough slack to allow for removal for service or maintenance.

**⚠ CAUTION:** It is suggested to locate the cell downstream of all other equipment and on the pool return line only to avoid over-saturation conditions of your spa. For applications other than as recommended, contact the factory.

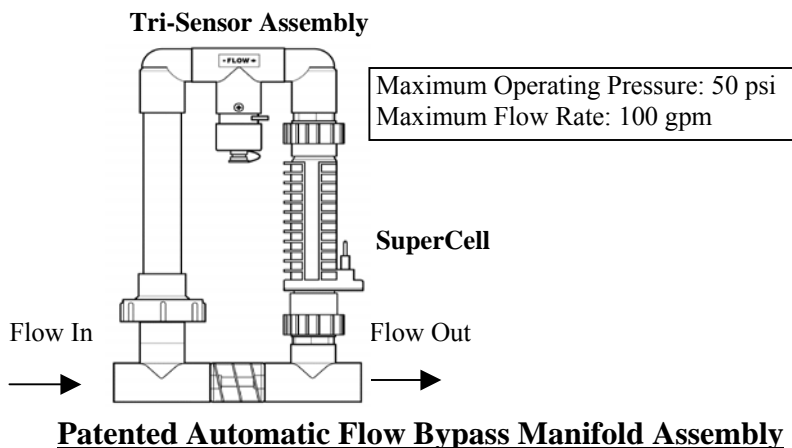

**ELECTROLYTIC SUPERCCELL** receives Low Voltage DC current from the Power Circuit Board, which initiates the electrolytic process. This process converts ordinary table salt (Sodium Chloride) to 100% Pure Sodium Hypochlorite (Chlorine Bleach) or Bromine (with the addition of Sodium Bromide), which in turn purifies your pool or spa. See page 8 for salt requirements.

**TRI-SENSOR ASSEMBLY** ensures that adequate **flow**, 15gpm (3.4 m<sup>3</sup>/hr) minimum; **salt**, 2500 – 3500 ppm (2,5 – 3,5 gm/l) ideal range; and **water temperatures**, above 55°F (13 °C) are satisfactory to prevent abusive conditions for the cell to operate. See page 10 for instructions to remove and inspect the tri-sensor assembly.

<b>Cl<sub>2</sub> Output Rating:</b>	SC-60	2.00 lbs/day (0.91 kg/day)
<b>@ Cell Power 3</b>	SC-48	1.56 lbs/day (0.71 kg/day)
<b>(8 amps DC)</b>	SC-36	1.28 lbs/day (0.58 kg/day)

**Agency Approvals:** NSF, ETL us, ETL c, CE

## Control Box Connections

### Electrical Connections

Autopilot recommends that a licensed electrician or certified electrical contractor perform the electrical connections.

**⚠ DANGER: ensure that the electrical panel or filter pump circuit breaker is turned OFF before wiring this unit.** Your Pool Pilot™ *Soft Touch* Control Box comes pre-wired from the factory for 230VAC (1.5 amps max draw) and can also operate on 115 VAC, (3.0 amps max draw) at 50/60Hz. Short test lead wire are attached to the terminal strip and must be removed prior to installation.

**Converting to 115VAC** is accomplished by accessing the circuit board, rewiring, and attaching the included jumper as shown below. Remove the cover (see page 10) to access and ensure that the Jumper Connections on the circuit board marked “TRANSFORMER PRIMARY” are matched to the LINE IN voltage. Follow all state/local codes for electrical installations.

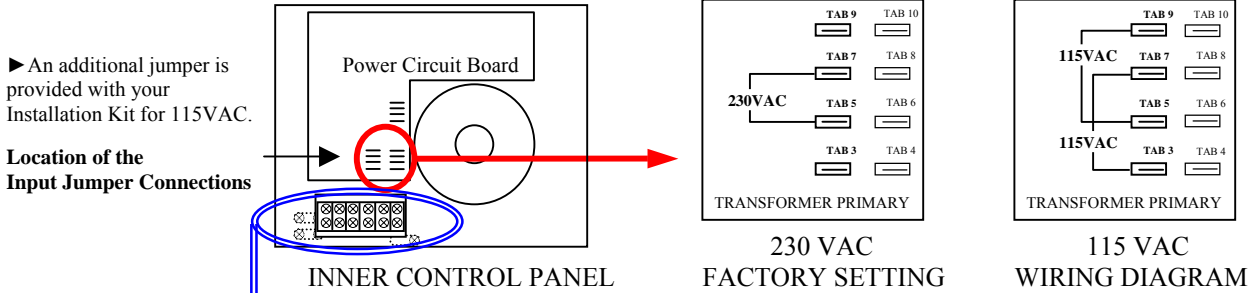

Top terminals factory wired – do not disturb.

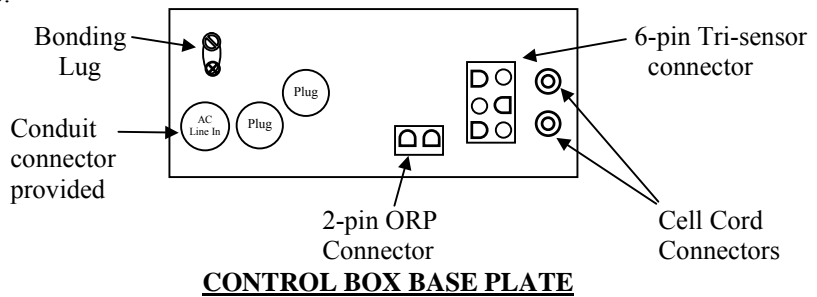
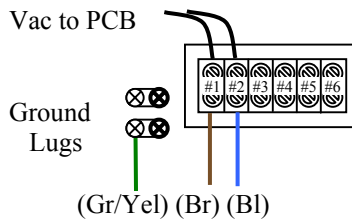

### AC LINE IN (Wiring diagram also located on inside of cover):

**For 230 VAC;** Brown (Br) = Line 1, Blue (Bl) = Line 2, Green w/Yellow Tracer (Gr/Yel) = Earth Ground

**For 115 VAC;** Brown (Br) = Line, Blue (Bl) = Neutral, Green w/Yellow tracer (Gr/Yel) = Earth Ground

Connect AC wires to Terminals #1, #2, and ground lug of the Pool Pilot from the **LOAD SIDE** of the time clock or the same location as the circulation pump wires (pump connected to circuit breaker, time clock or electronic controller)..

**Cell Cord.** Each Cell Cord contains (2) Banana Plugs that attach to the (2) Banana Jacks on the bottom of the Control Box. Polarity does not matter. The other end of the cell cord has a three-position plug that connects to the cell in any direction. For the SC-36 and SC-48 Cell Types, ensure the red cap is inserted into the hole not used. See page 11 for service instructions.

**Tri-Sensor Cord.** The Tri-Sensor Cord connects to the keyed 6-pin harness on the Control Box Base Plate. The opposite end of the cord connects to the Tri-Sensor Assembly with a locking ring quick connect. Align the groove and keyway on the connector and twist the locking ring to ensure a proper connection. Refer to the instructions on pages 10 & 12 for diagrams and additional instructions.

**ORP Connection.** When an ORP Chemical Controller is interfaced to your Pool Pilot™ *Soft Touch*, the Chemical Controller will remotely control the purifier Output. Adjust the output level to 0% (All Purifier Output lights off) and connect the ORP controller to the 2-pin connector on the Control Box Base Plate. When the ORP is activated, the system will generate chlorine. If it is desired to have a visual confirmation of chlorine generation with the ORP feed is on, increase the Purifier Output to show the first LED light by pressing the arrow up one time. When the ORP feed is on, this light will flash.

**⚠ WARNING: THE ORP CONNECTIONS ARE DRY CONTACT INPUTS, DO NOT ENERGIZE THESE INPUTS! DAMAGE TO THE CONTROL BOX WILL OCCUR AND WILL VOID THE WARRANTY.**

## Cell and Manifold Installation

Your Pool Pilot System is adaptable for use with either the SC-36, SC-48 or SC-60 cell. All models come pre-assembled with a Patented Automatic Flow Bypass Manifold Assembly. The manifold must be located as the last accessory in the **POOL RETURN LINE** only. For pool/spa combinations or special plumbing configurations, please contact the factory for assistance in locating the manifold.

**Standard Manifold Assembly (all models):**

**⚠ WARNING: Do not mount the manifold upside down.**

Maximum flow rate 100 gpm (22.6 m<sup>3</sup>/hr). We recommend using a 2 lb spring bypass check valve for flow rates greater than 100 gpm (22.6 m<sup>3</sup>/hr) and plumbing it parallel to the manifold. For Pool-Spa combinations, the manifold assembly must be mounted in the Pool return line, so as to avoid over saturation of the spa when isolated.

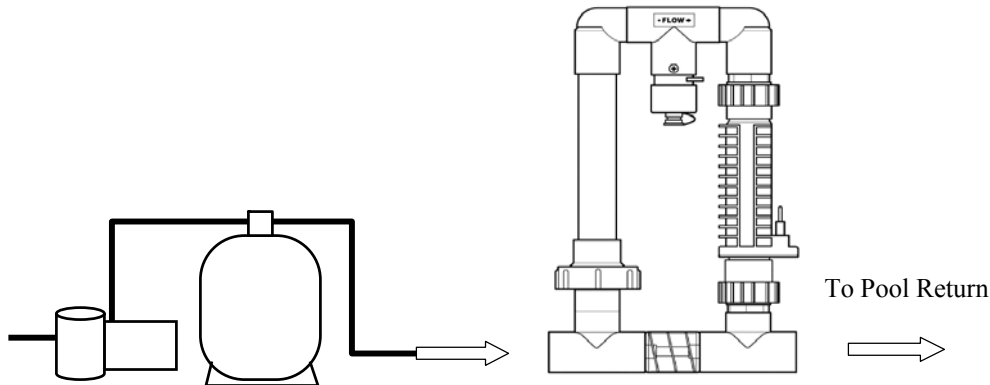

\*One set of 68mm x 2” metric adapters (#19059) included with European Systems. For other plumbing configurations, please contact the factory for assistance.

**Verification of Flow Switch Protection:**

It is important to annually inspect and verify the safe and proper operation of the Tri-sensor’s Flow Switch protection device. Autopilot recommends following this procedure to verify that the flow switch is working as designed, which is to halt power from being sent to the cell in the presence of insufficient flow. A defective Flow Switch can cause serious equipment damage. Using a small plastic wrap (saran wrap, food wrap or zip lock bag), block off flow to the upper portion of the manifold by wrapping the strainer screen with the plastic wrap and placing it back in the union and tightening. Operating the system on with this blockage should detect a FLOW obstruction, turning the FLOW-OK light off and activating a single red SERVICE flashing light. Once this protection feature has been verified, remove the plastic wrap, replace the strainer screen and resume operation. Turn the output dial to OFF and contact the factory if the flow switch protection does not activate properly.

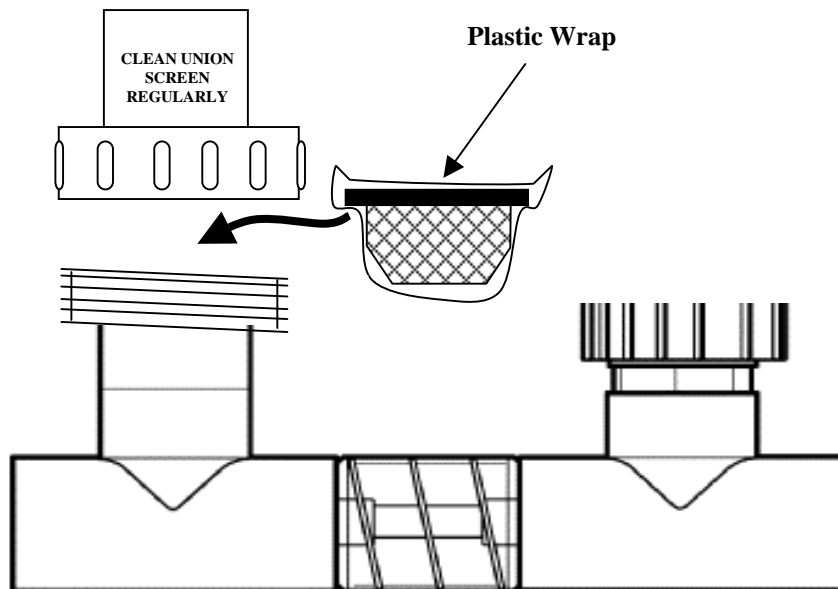

## Key Features

The **Control Panel Display** provides a series of control buttons for **OUTPUT** level, **BOOST** mode and **SETUP** functions, with diagnostic indicator lights for **FLOW-OK**, **SALT** and **SERVICE**. Two additional indicator lights show the selected setup **CELL POWER** and **REVERSING** cycle.

The Pool Pilot™ *Soft Touch* Purifying **OUTPUT** level is adjustable from 0% (OFF) to 100 % (MAX). Press the **Up/Down Arrows** to set the desired output level. When increasing or decreasing the Output with the Up/Down buttons, the three lights of the Cell Power and Reversing will light or not light at all, and will remain that way for a period of a few seconds. The Cell Power lights will stage up (increasing) or down (decreasing) to indicate the increments of output of each Output light. Little adjustment is needed once the initial setting is established. The selected output level will remain steady when the system is at rest and will begin flashing when the system is producing the purifying agent.

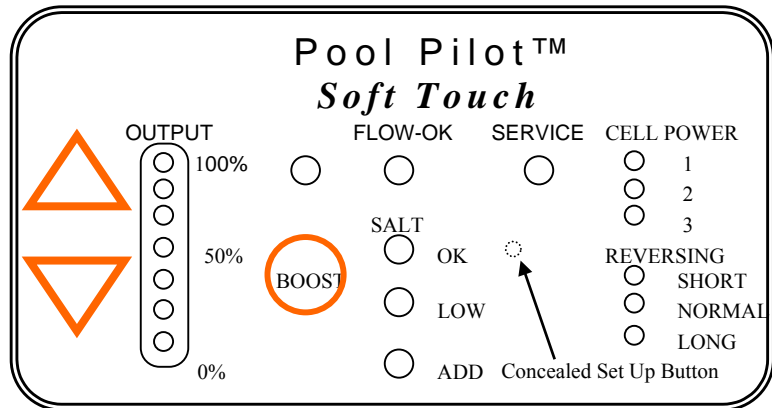

**Note: The Pool Pilot™ *Soft Touch* does not test for purifier levels nor automatically adjust to maintain a desired purifier level. This is done by periodically testing the water and adjusting the output levels up or down, as needed.**

The Pool Pilot *Soft Touch* is designed with an **AUTOMATIC TEMPERATURE COMPENSATION** feature, which automatically adjusts the output level setting based upon changes in seasonal water temperatures only. This unique feature conveniently compensates for warm (more purifier needed) or cold (less purifier needed) water conditions.

The **SETUP Mode** allows the user to program the **CELL POWER** and **REVERSING** cycle. To enter Setup Mode, press and hold the concealed Setup button (which can be felt under the label) until the **CELL POWER** light begins flashing. The Pool Pilot™ *Soft Touch* is set on “2” from the factory. Use the Up/Down Arrows to change the Cell Power setting. Adjust the **OUTPUT** level to the new setting to maintain proper sanitizer levels.

Pressing the Setup Button once more will go to the **REVERSING** cycle. The Pool Pilot™ *Soft Touch* is set on “**NORMAL**” from the factory for ideal cell life. Use the Up/Down Arrows to change the Reversing cycle. For conditions such as extremely high calcium levels or conditions that can cause the cell to scale quicker than the self-cleaning cycle can control, change the setting to “**SHORT**”. For optimum water chemistry balance according to the Saturation Index, see page 9, you can change the **REVERSING** cycle to “**LONG**”. Pressing the setup button once more will leave the Setup Mode and save the programmed Cell Power and Reversing settings. Test your water chemistry parameters monthly and compare to the Saturation Index.

**WARNING:** Changing the Reversing cycle to **SHORT** will also reduce cell life. However, operating the cell under scaled conditions on “Normal” or “Long” is more detrimental to the life of the cell, and changing the Reverse cycle is suggested.

The **BOOST Button** overrides the normal Purifier Output % and activates at 100%, indicated by a solid Boost Light, when it is pressed once, and will produce the purifying agent for 24 hours. The purifying agent can be produced for 72-hours, indicated by a flashing Boost Light, by pressing and holding the BOOST button for 8-seconds from the Boost-Off position. This is called the **Super-Boost Mode**. In either mode, the purifying agent is produced continuously, throughout the normal On/Off cycles of the pump and throughout all power line disturbances. The system will discontinue operation of the Boost or Super Boost mode after the 24-hr or 72-hr cycle has passed, or if the boost button is pressed once more, then return to the normal purifying output setting.

The **SALT** light indicates the salt level in the water. The salt level should be maintained between 2500 – 3500 ppm (2,5 – 3,5 g/l), where the **SALT-OK** light will display. If the salt level drops between 2400 - 2000 ppm (2,4 -2,0 g/l), the **SALT-LOW** light will display and the system will reduce efficiency in producing the purifying agent. If the salt level drops below 1900 ppm (1,9 g/l), the **SALT-ADD** light will display and the system will halt production of the purifying agent. The Pool Pilot™ *Soft Touch* can also handle special application salt levels of up to 35,000 ppm (35,0 g/l) without any adverse effects to the unit. (**NOTE:** HIGH Salt level does not affect purifier production but can cause corrosion problems with metallic fixtures, light rings, ladders and hand rails.) See Appendix (page 14) to determine your salt level.

The **FLOW-OK** light turns on when there is sufficient flow. Insufficient flow is indicated by the Flow-OK light off and a Flashing Service Light (single flash pattern).

The **SERVICE** light flashes when service is needed. Check the Troubleshooting Section, page 13, for troubleshooting solutions.



## Pool Water Preparation

### Salt Requirements

It is important that with typical pools, a salt residual of 2500 to 3500 ppm (2,5 – 3,5 g/l) be maintained at all times for peak efficiency. The Pool Pilot™ *Soft Touch* can also handle special application salt levels of up to 35,000 ppm (35,0 g/l) without any adverse effects to the unit.

**NOTE:** HIGH Salt level does not affect purifier production but can cause corrosion problems with metallic fixtures, light rings, ladders and handrails.

The amount of salt required depends on the size of the pool and the present salt level. As the salt is being added, we recommend running the circulation pump continually for 24 hours with the main drain opened. Brushing the salt towards the bottom main drain will assist in the dissolve rate and prevent possible staining with certain types of salt.

We recommend the use of **AutoSoft Plus™** Water Conditioning Salt. **AutoSoft Plus™** salt contains 99.8% pure Sodium Chloride (NaCl) without Iodine or the Anti-Caking additive, Yellow Prussiate of Soda (YPS). Iodine and YPS can cause a localized tint to the water or yellow staining on the cementitious finish if allowed to rest undissolved on the finish for extended periods of time. **AutoSoft Plus™** is blended with the proper amount of stabilizer to maintain a proper level within the recommended range when added according to the salt chart on the box.

Granular Salt, Table Salt, Solar Salt or Water Conditioner Pellets can also be used but will have different dissolve rates. If the salt you use contains Iodine or YPS, constant brushing will help the dissolve rate and prevent staining due to the additives in the salt. Ensure that the salt you use contain a minimum purity of 99% Sodium Chloride (NaCl).

**NOTE: Do not use Rock Salt due to its high levels of impurities.**

**TEST YOUR WATER FOR SALT LEVEL FIRST** with the provided salt test strips, and then use the chart below to determine the amount of salt to add.

### SALT REQUIREMENT CHART

<b>POUNDS (kg) OF SALT NEEDED FOR 3000 PPM RESIDUAL</b>								
<b>SALT Level Before Addition</b>	<b>Pool Volume in Gallons (m<sup>3</sup>)</b>							
	<b>1,000 (3.77)</b>	<b>2,500 (9.43)</b>	<b>5,000 (18.9)</b>	<b>7,000 (28.3)</b>	<b>10,000 (37.7)</b>	<b>15,000 (56.6)</b>	<b>20,000 (75.4)</b>	<b>30,000 (123.2)</b>
<b>0 ppm</b>	25 (11.3)	63 (28)	126 (57)	175 (79)	252 (113)	378 (170)	504 (227)	756 (340)
<b>500 ppm</b>	21 (9.5)	53 (24)	106 (48)	147 (66)	212 (95)	318 (175)	424 (191)	636 (286)
<b>750 ppm</b>	19 (8.6)	48 (22)	96 (43)	133 (60)	192 (86)	288 (130)	384 (173)	576(259)
<b>1000 ppm</b>	17 (7.7)	43 (19)	86 (39)	119 (54)	172 (77)	258 (116)	344 (155)	516 (232)
<b>1500 ppm</b>	13 (5.9)	33 (15)	66 (30)	91 (41)	132 (59)	198 (89)	264 (119)	396 (178)
<b>2000 ppm</b>	8 (3.6)	21(9.5)	42 (19)	56 (25)	84 (38)	126 (57)	168 (76)	252 (113)
<b>2250 ppm</b>	6 (2.7)	15 (7)	30 (14)	42 (19)	60 (28)	90 (41)	120 (54)	180 (81)

**Note:** The above chart is based on 1 lb. (2.2 kg) of salt added to 1,000 gallons (3.8 m<sup>3</sup>) to increase your salt residual 120-ppm.

## Start Up Procedures

Keep the Output Setting on your Pool Pilot™ *Soft Touch* on 0% (OFF) until you get your water clear, blue and properly balanced.

1. After balancing your water chemistry according to the Water Chemistry Parameters shown on page 9, add the proper amount of salt (see Salt Requirement Chart above) and circulate 24-hours prior to starting your Pool Pilot™ *Soft Touch*.
2. The following day, turn your Output Level to 50% and operate normally. For the first two weeks, test the water every 2-3 days for proper Purifier levels. Raise or Lower the Output Control Setting as needed, according to your test results.
3. Once your Output Level has been established, you will only need to adjust your chlorine level according to increased bather usage by increasing the Purifier Output % or by using the Boost button.

## Monitoring and Maintenance

**Water Chemistry Parameters - VERY IMPORTANT NOTE!** Your Pool Pilot™ *Soft Touch* is designed to provide Purifier on a daily basis. We recommend the following water chemistry ranges and periodic checks to monitor your systems efficiency. Always follow all local and state requirements.

Biweekly Checks:		Monthly Checks:	
<b>Free Chlorine:</b>	1.0 – 3.0 PPM	<b>Calcium Hardness:</b>	200 – 400 PPM
<b>Or Bromine:</b>	2.0 – 4.0 PPM	<b>Total Alkalinity:</b>	80 – 120 PPM
<b>pH:</b>	7.2 – 7.8	<b>Cyanuric Acid:</b>	60 – 80 PPM
		<b>Salt Residual:</b>	2500 – 3500 PPM
		<b>Saturation Index:</b>	± 0.3 pH of saturation
		<b>Visual Cell Inspection</b>	for wear, scale or debris

**CHLORINE/BROMINE REQUIREMENTS:** During Peak Purifier Demand (rainy season or heavy bather usage) it may be necessary to increase your purifier level by increasing your Output Level setting and/or pump run time. Conversely, during Low Purifier Demand, you can decrease your Output Level to a lower setting. For extremely Heavy Purifier Demand or to boost your purifier levels quickly, you can **Boost** the system or supplement with a Potassium Monopersulfate based shock. If the water is clear but is difficult getting a bromine residual using DPD or test strips, we recommend using an OTO test kit.

**NOTE: During cold-water conditions, below 60°F, Purifier demand is reduced significantly.** For colder climate regions with sustained low or freezing temperatures, contact your local pool professional for proper pool winterizing instructions.

**⚠️ WARNING:** Excessive chlorine levels can cause corrosion damage to stainless steel rails, ladders, heater heat exchangers, light faceplates and other metallic equipment. Avoid over saturation of chlorine levels.

**pH:** When pH levels fall below the recommended range, Purifier is used up quickly and can be damaging to equipment. For pH levels higher than the recommended range, Purifier becomes less effective and works harder to keep your pool purified. Improper pH also contributes to the strong smell, red eyes, dry itchy skin and brittle hair conditions associated with “too much Chlorine”.

**CALCIUM HARDNESS AND TOTAL ALKALINITY:** Your Pool Pilot™ *Soft Touch* provides 100% pure sodium hypochlorite and does not affect the calcium hardness or total alkalinity levels. Maintain and balance only as needed.

**CYANURIC ACID (STABILIZER/CONDITIONER):** This chemical goes by either trade name and allows the chlorine residual to last longer by protecting it from the UV degradation of the sun. With low or no Cyanuric acid it is possible for the chlorine to be used up as quickly as it enters the pool. Check and maintain your cyanuric acid levels at the same time as your salt level, as these tend to deplete at the same rate.

**NOTE: For Bromine or indoor pools, it is not necessary to add stabilizer.**

**SALT RESIDUAL:** Your Pool Pilot™ *Soft Touch* works most efficiently with salt levels between 2500- 3500 ppm (2,5 – 3,5 g/l). If it falls below 2500 ppm (2,5 g/l), determine the salt level and adjust according to the SALT REQUIREMENT. Low salt will cause premature deterioration of the Cell blades. For “SEAWATER” pools, your Pool Pilot™ *Soft Touch* is designed to handle up to 35,000 ppm (35,0 g/l), however, salt levels above 6000 ppm (6,0 g/l) can be corrosive to metallic fixtures.

**BROMINE RESIDUAL:** Along with the normal Salt level, add 1lb (0.45 kg) Sodium Bromide (NaBr) per 2000 gallons (0.75 m³) of water. Your Pool Pilot™ *Soft Touch* will now generate Bromine to purify your pool. Maintain your bromine level by checking your salt level. Once your salt falls below the recommended range, we suggest you add 1lb (0.45 kg) sodium bromide with every 50 lbs (22.5 kg) of salt added. We recommend testing Bromine Purifier levels with an OTO test kit.

**SATURATION INDEX (SI):** a formula used to ensure that your total water chemistry does not fall into a scale forming or corrosive condition. Either condition can cause premature damage to the Cell, equipment and cementitious finish. Have your water professionally tested periodically according to the Saturation Index or use this chart to determine your water balance.

$$SI = pH + TF + CF + AF - \text{Constant}$$

Temperature		TF	Calcium Hardness	CF	Total Alkalinity	AF	TDS	Constant
60F	15.6C	<b>0.4</b>	150	<b>1.8</b>	75	<b>1.9</b>	0 – 1000	<b>12.1</b>
66F	18.9C	<b>0.5</b>	200	<b>1.9</b>	100	<b>2.0</b>	1001 +	<b>12.2</b>
76F	24.4C	<b>0.6</b>	250	<b>2.0</b>	125	<b>2.1</b>		
84F	28.9C	<b>0.7</b>	300	<b>2.1</b>	150	<b>2.2</b>		
94F	34.4C	<b>0.8</b>	400	<b>2.2</b>	200	<b>2.3</b>		
103F	39.4C	<b>0.9</b>	600	<b>2.4</b>	250	<b>2.4</b>		

Test your water for pH, Calcium Hardness, Total Alkalinity and TDS levels. Use the equivalent Factor in the SI equation.

**SI = ±0.3; balanced**

SI above + 0.3; scaling, staining or cloudy water conditions.

SI below -0.3; corrosive to metals, etches/deteriorates plaster finishes or skin irritating conditions.

## CONTROL BOX

There are little serviceable parts on the Pool Pilot™ *Soft Touch* Control Box except the fuses. For any other problems with the Control Box, please contact the Factory or Authorized Dealer/Service Center.

To remove the Control Box Cover and access the fuses, follow these steps.

**⚠ DANGER: TURN OFF THE POWER FROM THE CIRCUIT BREAKER BEFORE SERVICING THIS UNIT.**

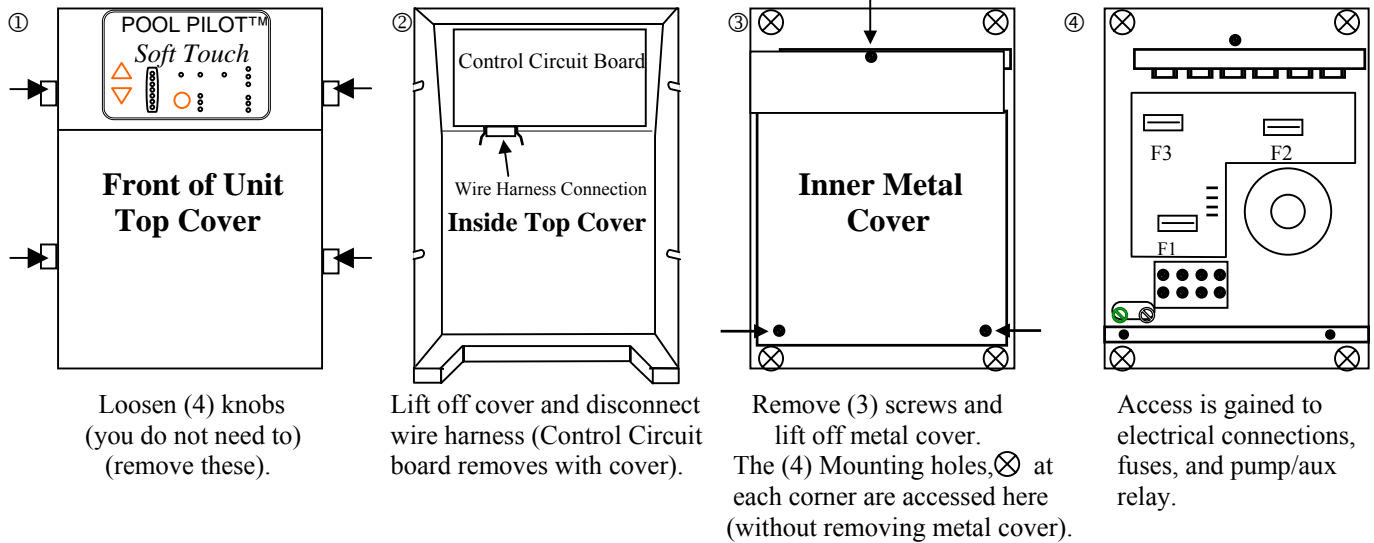

### Fuse Location and Ratings

F1	Main AC Power Fuse	3 Amps 250 VAC (230 Volts)
F2	Control Panel Circuit Board Fuse	6 Amps 250 VAC (115 Volts)
F3	Cell Fuse	3 Amps 250 VAC
		20 Amps 250 VAC

## TRI-SENSOR ASSEMBLY

The Tri-sensor assembly tests for Flow, Salt and Water temperatures. A minimum flow rate of 15 gpm (3.4 m<sup>3</sup>/hr) is required to activate the flow switch. As the water flow closes the paddle, a magnet activates a micro switch to verify proper flow. The Salt sensor protects against low salt levels and the temperature sensor protects against cold water temperatures. Both of which can contribute to accelerated cell failure.

► **Note:** The use of high strength magnet devices in the close proximity of the tri-sensor can cause the flow switch to read incorrectly.

### Remove the Tri-Sensor as follows (with pump off):

Remove both screws from the sides of the Tee Assembly. With the aid of large Channel-lok® (or similar) pliers, firmly grip the Tri-Sensor assembly and move back and forth while removing the Tri-Sensor from the tee. Inspect the thin metallic paddle for erosion and straightness. Take care not to twist or tweak this paddle, which can cause inaccurate flow readings. Inspect the salt sensor blades for scale and debris and clean if necessary. See page 13 for cleaning instructions. Follow the directions for Manual Cell Cleaning. Check the tri-sensor assembly for any damage to the plastic housing and replace if needed.

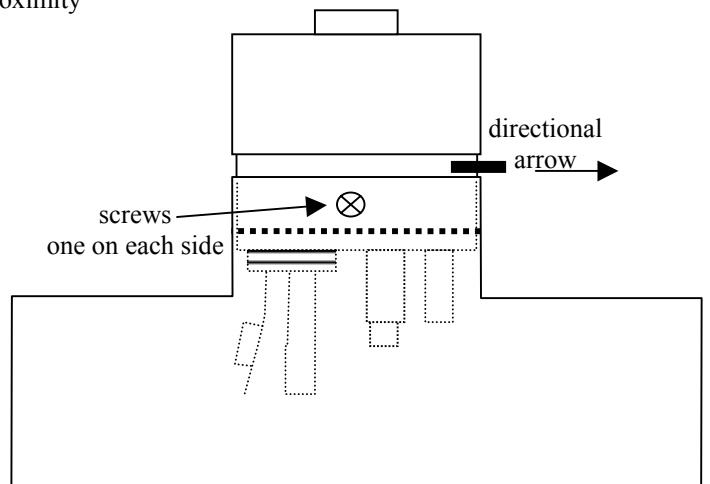

## Cell

The Cell is installed with Unions on each end of the cell to allow quick and easy removal. Loosen the unions and remove the cell from the plumbing.

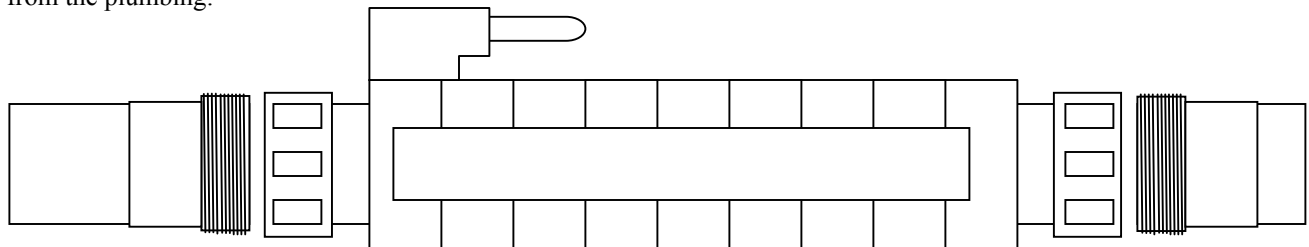

Side View of Cell and Unions

**VISUAL CELL INSPECTION:**

The titanium Cell blades, seen inside the Cell body, should be straight and clear of any debris between the blades. Your Pool Pilot™ *Soft Touch* is designed to automatically self-clean calcium scale build-up within the Cell. However, imbalanced water chemistry and certain conditions can cause a heavier scale build up that exceeds the self-cleaning capability and would need to be cleaned manually by the method described below.

Periodically inspect both ends of the cell. A White Flaky or Crusty build-up on the edge or between the blades will prematurely deplete the life of the cell. Immediately clean the cell and determine the cause of scaling. See Troubleshooting Section, page 13.

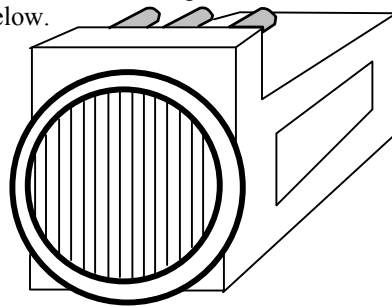

End View of cell  
Looking at the Titanium Blades

**MANUAL CELL CLEANING:**

With the Cell removed as described above, use a high-pressure hose nozzle to spray off as much loose scale and debris as possible. Any remaining calcium scale can be treated with a mixture of one (1) part Muriatic Acid into four (4) parts water. Mix the solution in a container high enough to cover the Cell blades.

Remove the Cell cord and immerse the Cell so that the blades are completely covered in the solution for up to 15 minutes. An effervescences action indicates the calcium is being neutralized and cleaned. Drain the cell, flush with fresh water and re-inspect. Repeat the immersion if necessary.

We recommend using **Lo-Chlor Salt Cell Protector Plus** as a prevention additive to continually help soften and reduce build-up of calcium scale deposits in the cell. This product also reduces calcium scale on exposed aggregate finishes and new pool finishes and enhances chlorine production.

**⚠ DANGER: ALWAYS ADD ACID TO WATER, never water to acid.**

**NEVER USE ANY SHARP OR METALLIC OBJECTS TO REMOVE SCALE. Scraping or scratching the titanium blade's edge or surface will allow chemical attack of the blade, cause premature failure of the Cell and will void your warranty.**

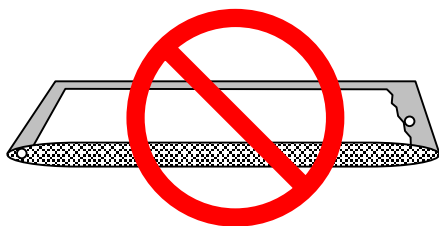

**Hacksaw Blades**

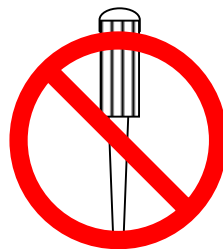

**Screwdrivers**

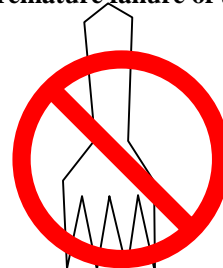

**Forks**

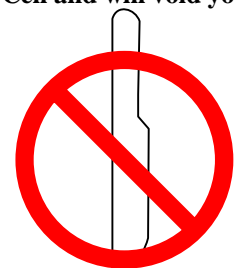

**Knives**

**FILTER BACKWASHING:**

We recommend turning the Control Panel Output setting to 0% (OFF) when backwashing a Sand or DE filter.

# Parts Explosion

**Manifold Assembly:**

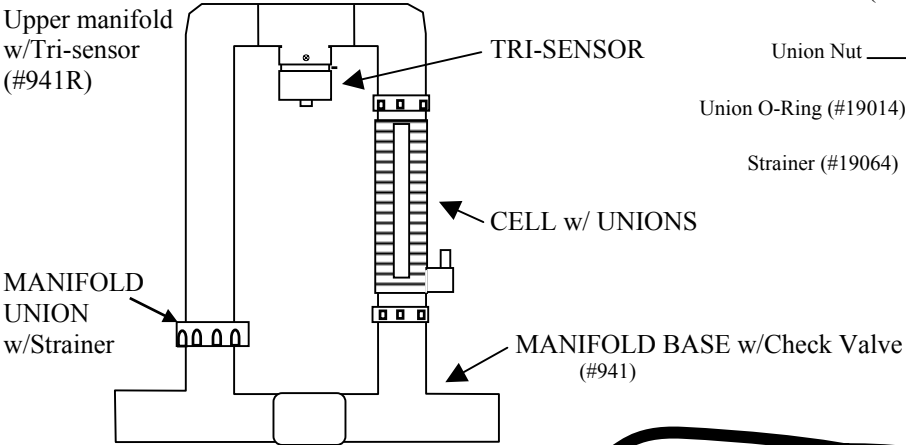

**Manifold Union w/Strainer:**

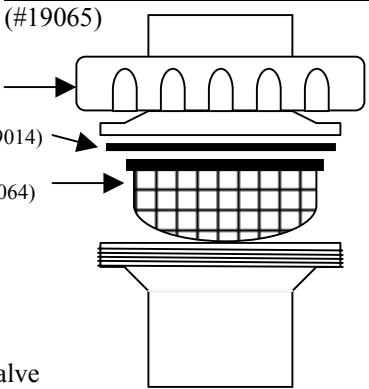

**Electrolytic Cell:**

(Cell Unions and Cord ordered separately)

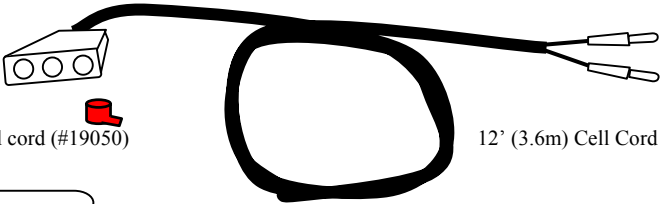

**UNION COMPLETE (#19070)**

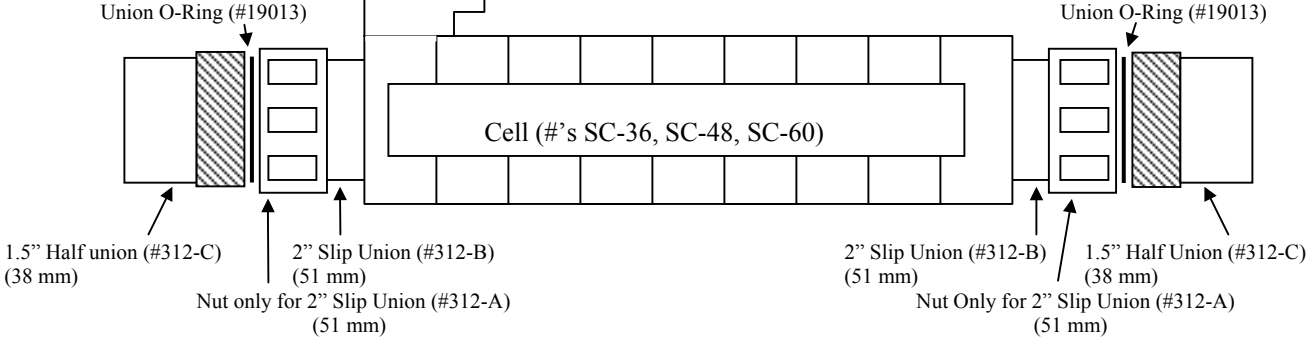

**Tri-Sensor Assembly:**

(Cord Ordered Separately)

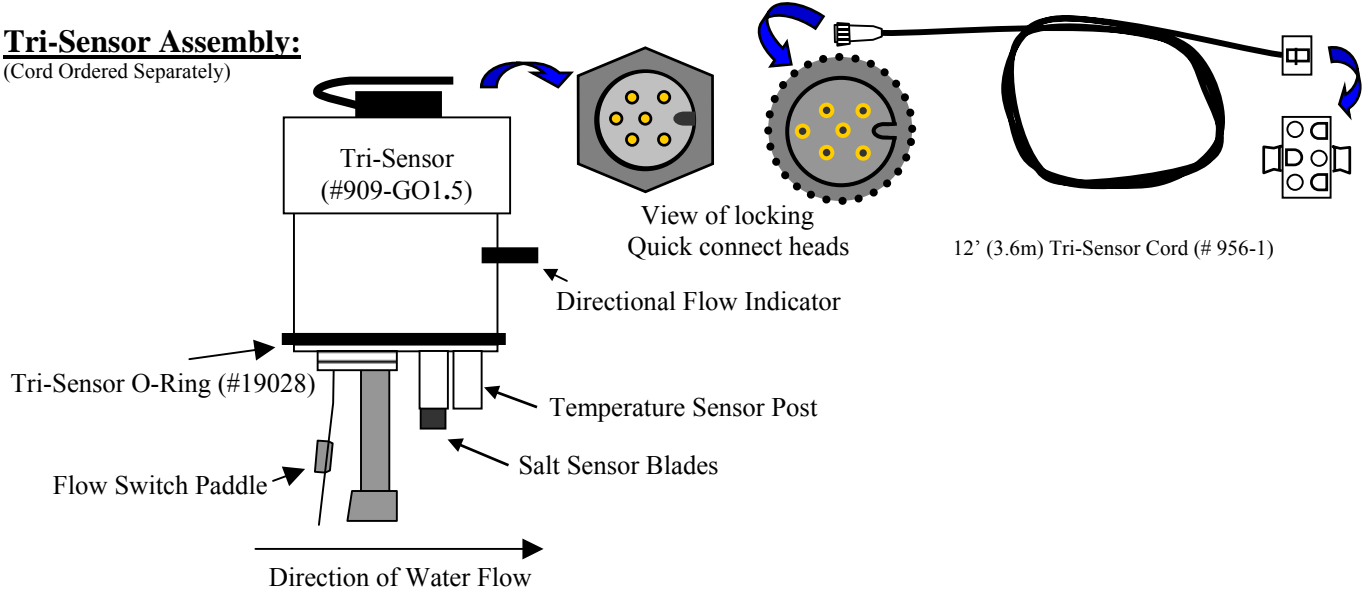

## TRUBLESHOOTING

<u>PROBLEM</u>	<u>CAUSE</u>	<u>SOLUTION</u>
1) <b>Insufficient Purifier Production.</b>	<p>A) The test kit reagents or test strips are old or expired.</p> <p>B) The unit is set too low in relation to purifier demand.</p> <p>C) The circulation run time is insufficient.</p> <p>D) The bather load has increased.</p> <p>E) The body of water being purified leaks.</p> <p>F) Low Salt.</p> <p>G) “Cell Power” selection not matched to the cell installed.</p> <p>H) Purifier loss due to intense sunlight</p>	<p>A) Retest with new Reagents or Strips.</p> <p>B) Turn up the output setting.</p> <p>C) Increase your pump run time.</p> <p>D) Same solution as (B) or add a Non-Chlorine Shock containing Potassium Monopersulfate to supplement.</p> <p>E) Repair the leak and rebalance as needed.</p> <p>F) Check the residual salt level and adjust as needed.</p> <p>G) Follow the SET UP procedures to match the cell, see page 7.</p> <p>H) Check your stabilizer level and adjust if needed.</p>
2) <b>Scale Build-up within the Cell.</b>	<p>A) The water being purified contains high pH, total alkalinity and calcium hardness levels. (Cell scales within 2 – 3 weeks)</p> <p>B) Power Supply not reversing polarity. (Cell constantly scales within 3 – 5 days)</p>	<p>A) Calculate Saturation Index to assure balanced water. Adjust chemicals and clean the Cell. See pages 9 &amp; 11.</p> <p>B) Contact the factory for Warranty Status/Procedures.</p>
3) <b>DC Plug and Cell Terminals Burned.</b>	<p>A) The Cell terminals are wet due to a leaking cell body.</p> <p>B) The Cell plug is not securely pushed onto the cell terminals, allowing moisture to seep into the plug.</p>	<p>A) Contact the factory for Warranty Status/Procedures.</p> <p>B) Ensure the Cell cord plug is pressed completely onto the Cell terminal. Check the terminals and clean with a dry cloth to remove all dirt and corrosion.</p>
4) <b>Premature Cell Failure (Requires Replacement Cell).</b>	<p>A) Abnormally high Cell usage due to an insufficient Stabilizer (Cyanuric acid) level.</p> <p>B) Excessive Scale/Debris in the Cell.</p> <p>C) “Cell Power” selection not matched to the Cell installed.</p>	<p>A) Check the stabilizer level and adjust to recommended levels.</p> <p>B) See Section 2 above.</p> <p>C) Follow the SETUP procedures to match the cell, see page 7.</p>
5) <b>White Flakes in the Water.</b>	<p>A) This occurs when excessive calcium hardness is present. Usually due to water chemistry imbalance.</p>	<p>A) Visually inspect Cell for scale build-up and clean the cell as described on page 11. Adjust your water chemistry.</p>
6) <b>No Power to the Control Box.</b>	<p>A) Internal Fuse blown.</p> <p>B) Circuit Breaker tripped.</p>	<p>A) Check and replace fuse. See page 10.</p> <p>B) Check the power going to the Control Box. Reset the Circuit Breaker.</p>
7) <b>SERVICE Light (Single RED Flash and Flow-OK light off).</b>	<p>A) Tri-Sensor Defective.</p> <p>B) Insufficient Flow (Min. 15 gpm) (3.4 m<sup>3</sup>/hr)</p>	<p>A) Contact the factory for Warranty Status/Procedures.</p> <p>B) Ensure your Filter and Cell are clean of debris. Check all valves that might divert flow away from the cell.</p>
8) <b>SERVICE Light (Double RED Flash)(Purifier is producing).</b>	<p>A) High Cell Volts with Low Amps</p>	<p>A) Check cell for calcium build-up or scale deposits. Cell is depleted and needs replacement. Cell cord is loose or defective. Ensure that the cord is firmly attached to the cell. Check the Banana Plug connections.</p>
9) <b>SERVICE Light (Triple RED Flash)(Purifier production halted).</b> (Microprocessor version V1.4 or older)	<p>A) High Cell volts with Extremely Low Amps.</p>	<p>A) Heavily scaled cell or failed cell.</p>
(Microprocessor version V1.5 or newer)	<p>A) Improperly wired or failed Power Supply.</p>	<p>A) Ensure voltage input matches wiring connection (page 5).</p>
10) <b>SERVICE Light (Quadruple RED Flash)(Purifier is producing).</b>	<p>A) Tri-sensor or tri-sensor cord is loose or defective.</p>	<p>A) Inspect and tighten or replace.</p>
11) <b>LOW SALT Light activated (Purifier is producing) .</b>	<p>A) Salt level Low (below 2400 ppm (2,4 g/l)).</p>	<p>A) Check with Salt test strips or meter and adjust as needed.</p>
12) <b>ADD SALT Light activated (Purifier production halted).</b>	<p>A) Salt level extremely low (below 2000 ppm (2,0 g/l)).</p>	<p>A) Check with Salt test strips or meter and adjust as needed.</p>
13) <b>Unable to set output to a high level.</b>	<p>A) Temperature is too low (below 55F (13C)).</p>	<p>A) The Pool Pilot has limited output to protect the cell.</p>

## BUILT-IN DIAGNOSTICS

The Pool Pilot™ Soft Touch Control Box contains a way to display a diagnostic report on its operation. It allows the user to view the salt concentration, the water temperature, and the Electrolytic Cell voltage and amperage. This is provided for a technician to evaluate the performance of the Pool Pilot without the need for special equipment. The values are measured by counting the number of flashes of the lights, as described below.

To access and interpret the diagnostics, follow this procedure:

To start the diagnostic procedure, press and hold both the UP and DOWN buttons at the same time. Hold them pressed until the output display lights go out, leaving just the bottom light illuminated (about 5 seconds).

1. The **first** value to be displayed is the **salt concentration** in Parts Per Million (PPM). This value is measured by counting the number of flashes of the top 3 lights. In the case of salt, the top light is not used, the next to the top flashes the 1000's digit and the third light flashes the 100's digit in ppm.  
 Example: 2 flashes/pause/8 flashes/pause      Read: 2,800 PPM
2. The **second** value is the **water temperature** in degrees Fahrenheit. When this is displayed, the second light from the bottom is on. The top light flashes the 100's digit, the next the 10's digit and the next the units of temperature.  
 Example: 8 flashes/pause/6 flashes/pause      Read: 86 Degrees F
3. When the **third** light from the bottom is on, the **cell voltage** is displayed. The top light is not used. The second light flashes the 10's digit and the third the units of voltage.  
 Example: 2 flashes/pause/8 flashes/pause      Read: 28 Volts
4. When the **fourth** light is on the **cell current** in amperes is being displayed. The top light displays the 10's digit (not normally used), the next the units and the third the tenths of amps.  
 Example: 5 flashes/pause/5 flashes/pause      Read: 5.5 Amps

The diagrams below summarize the built-in diagnostic displays.

<u>SALT</u>	<u>TEMPERATURE</u>	<u>VOLTS</u>	<u>AMPS</u>
○	● x100 °F	○	● x10 A
● x1000 ppm	● x10 °F	● x10 V	● x1 A
● x100 ppm	● x1 °F	● x1 V	● x0.1 A
○	○	○	● (Amps)
○	○	● (Volts)	○
○	● (Temperature)	○	○
● (Salt)	○	○	○